

# REMOTE DISCHARGE PROBE MODEL 9902



## Operating Instructions

12/17



**electro-tech systems, inc.**

[www.electrotechsystems.com](http://www.electrotechsystems.com)

3101 Mt. Carmel Avenue, Glenside, PA 19038 • Tel: (215) 887-2196 • Fax: (215) 887-0131

# **IMPORTANT SAFETY INSTRUCTIONS**

(Equipment containing HV)

The equipment described in this Manual is designed and manufactured to operate within defined design limits. Any misuse may result in electric shock or fire. To prevent the equipment from being damaged, the following rules should be observed for installation, use and maintenance. Read the following safety instructions before operating the instrument. Retain these instructions in a safe place for future reference.

## **POWER**

**POWER CORD:** Use only the power cord specified for this equipment and certified for the country of use. If the power (mains) plug is replaced, follow the wiring connections specified for the country of use. When installing or removing the power plug **hold the plug, not the cord.**

The power cord provided is equipped with a **3-prong grounded plug (a plug with a third grounding pin)**. This is both a safety feature to avoid electrical shock and a requirement for correct equipment operation. If the outlet to be used does not accommodate the 3-prong plug, either change the outlet or use a grounding adapter.

**FUSES:** Replace fuses only with those having the required current rating, voltage and specified type such as normal blow, time delay, etc. **DO NOT** use makeshift fuses or short the fuse holder. This could cause a shock or fire hazard or severely damage the instrument.

**POWER LINE VOLTAGE (MAINS):** If the line (mains) voltage is changed or isolated by an autotransformer the common terminal **must** be connected to the ground (earth) terminal of the power source.

## **OPERATION**

### **CAUTION**

Equipment designed to simulate a high voltage electrostatic discharge such as the Series 900 ESD Simulators and the Model 4046 Static Decay Meter utilize voltages up to 30kV. The basic nature of an ESD event will result in electromagnetic radiation in addition to the high level, short duration current pulse. **Therefore, personnel with a heart pacemaker must not operate the instrument or be in the vicinity while it is being used.**

**DO NOT OPERATE WITH COVERS OR PANELS REMOVED.** Voltages inside the equipment can be as high as 30kV. In addition, equipment may contain capacitors up to 200pF charged to 2kV. Capacitors can retain a charge even if the equipment is turned off.

**DO NOT OPERATE WITH SUSPECTED EQUIPMENT FAILURES.** If any odor or smoke becomes apparent turn off the equipment and unplug it immediately. Failure

to do so may result in electrical shock, fire or permanent damage to the equipment. Contact the factory for further instructions.

**DO NOT OPERATE IN WET/DAMP CONDITIONS:** If water or other liquid penetrates the equipment, unplug the power cord and contact the factory for further instructions. Continuous use in this case may result in electrical shock, fire or permanent damage to the equipment.

**DO NOT OPERATE IN HIGH HUMIDITY:** Operating the equipment in high humidity conditions will cause deterioration in performance, system failure, or present a shock or fire hazard. Contact the factory for further instructions.

**DO NOT OPERATE IN AREAS WITH HEAVY DUST:** Operating the equipment in high dust conditions will cause deterioration in performance, system failure, or present a shock or fire hazard. Contact the factory for further instructions.

**DO NOT OPERATE IN AN EXPLOSIVE ATMOSPHERE:** Operating the equipment in the presence of flammable gases or fumes **constitutes a definite safety hazard.** For equipment designed to operate in such environments the proper safety devices must be used such as dry air or inert gas purge, intrinsic safe barriers and/or explosion-proof enclosures.

**DONOT USE IN ANY MANNER NOT SPECIFIED OR APPROVED BY THE MANUFACTURER:** Unapproved use may result in damage to the equipment or present an electrical shock or fire hazard.

## **MAINTENANCE and SERVICE**

**CLEANING:** Keep surfaces clean and free from dust or other contaminants. Such contaminants can have an adverse affect on system performance or result in electrical shock or fire. To clean use a damp cloth. Let dry before use. Do not use detergent, alcohol or antistatic cleaner as these products may have an adverse affect on system performance.

**SERVICE:** Do not attempt to repair or service the instrument yourself unless instructed by the factory to do so. **Opening or removing the covers may expose you to high voltages, charged capacitors, electric shock and other hazards. If service or repair is required, contact the factory.**

## 1.0 INTRODUCTION

The ETS Model 9910 Electrostatic Discharge Simulator evaluates the ESD susceptibility of electronic devices using either the Human Body (HBM) or the Machine (MM) Models. The Human Body Model utilizes a 100pF capacitance discharged through a 1500 Ohm resistor up to  $\pm 8\text{kV}$  with a resolution of 1 Volt.

The Machine Model uses a 200pF capacitance discharged through 0 Ohms and operates up to  $\pm 1\text{kV}$ .

The Charged Device Model (CDM) is only available with the ETS Model 9903.

All discharge functions are performed using the 6" (154mm) discharge cables that plug into the Simulator front panel.

There are certain applications where it is desired to apply an ESD pulse to devices that either may not conveniently fit onto one of the Model 9910 discharge modules or added to an automatic pick and place test set up.

The ETS Model 9902 is a remote probe that operates only up to  $\pm 1\text{kV}$  for all discharge Models. The Model 9910 must be set to CDM or MM mode to provide the necessary signals to operate the Probe. The Probe shown in Figure 1.0-1 can only be used as a handheld device.



Figure 1.0-1: Model 9902 Remote Discharge Probe

## 2.0 DESCRIPTION

The Model 9902 is housed in an aluminum tube measuring 8.0" (203mm) long by 1.25" (32mm) diameter. It includes a removable discharge head with a replaceable spring-loaded pointed discharge tip and a set of 9" long discharge cables that are terminated with standard 0.161" (4mm) banana plugs plus a pair of spring-loaded adapters with pointed spring-loaded discharge tips for attachment to a pick and place. Red and Black 0.5" (6mm) jumpers are provided to select the HBM and MM functions. The Remote Probe is connected to the Model 9910 via a 6' (1.8m) cable assembly that consists of high voltage, ground and control signal leads. The supplied assembly is shown in Figure 2.0-1.

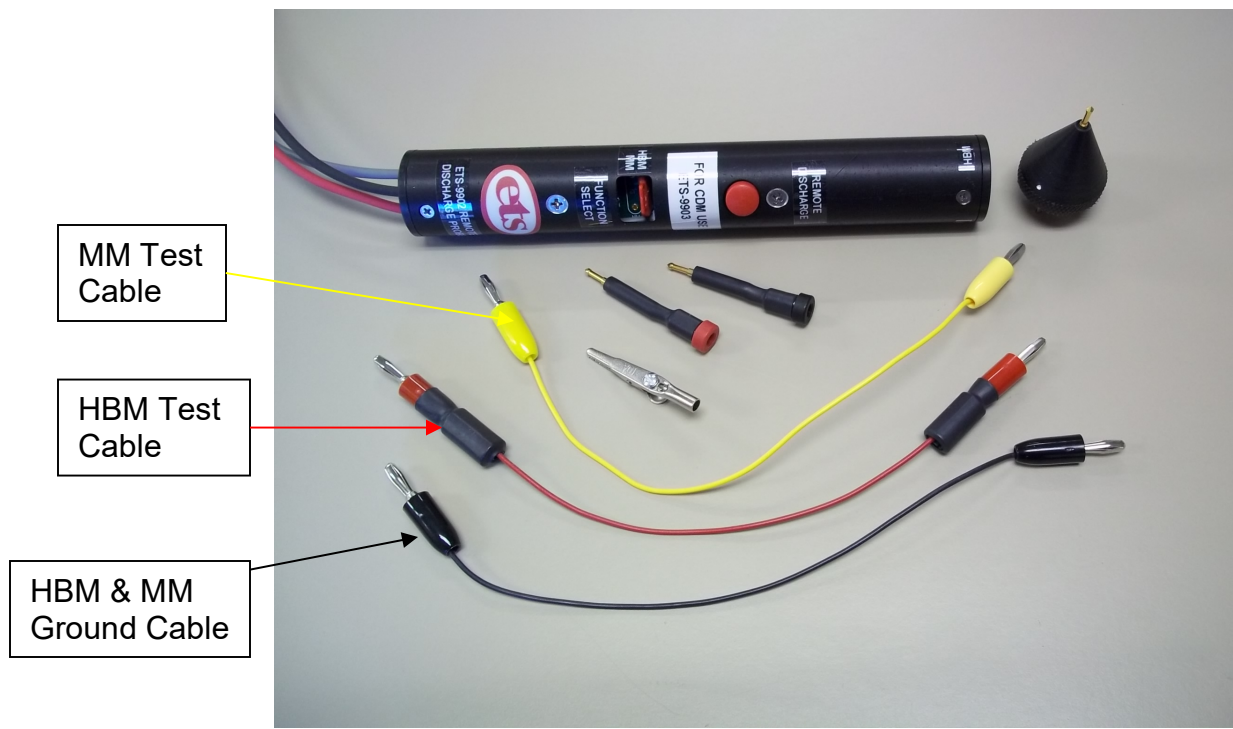

Figure 2.0-1: Model 9902 plus accessories

Each discharge function requires its own unique set of cables in order to achieve the required waveform. This will be covered in detail in Section 3.0 SET UP.

A manual remote discharge button is also included in the Remote Probe assembly.

When the discharge head is used the position of the white dot indicates which function the discharge tip is connected.

## 3.0 SET UP

The Model 9902 **MUST ALWAYS BE HELD OR MOUNTED VERTICALLY**. The assembly contains mercury-wetted relays that operate only in the vertical mode. However, when holding the Probe it may be offset by as much as 30 degrees from the vertical and still operate satisfactorily.

### 3.1 Connection to Model 9910

The Model 9910 **MUST BE SET IN CDM or MM MODE** in order for the Model 9902 Remote Discharge Probe to operate correctly. Figure 3.0-1 shows the Probe connections to the rear panel of the Simulator.

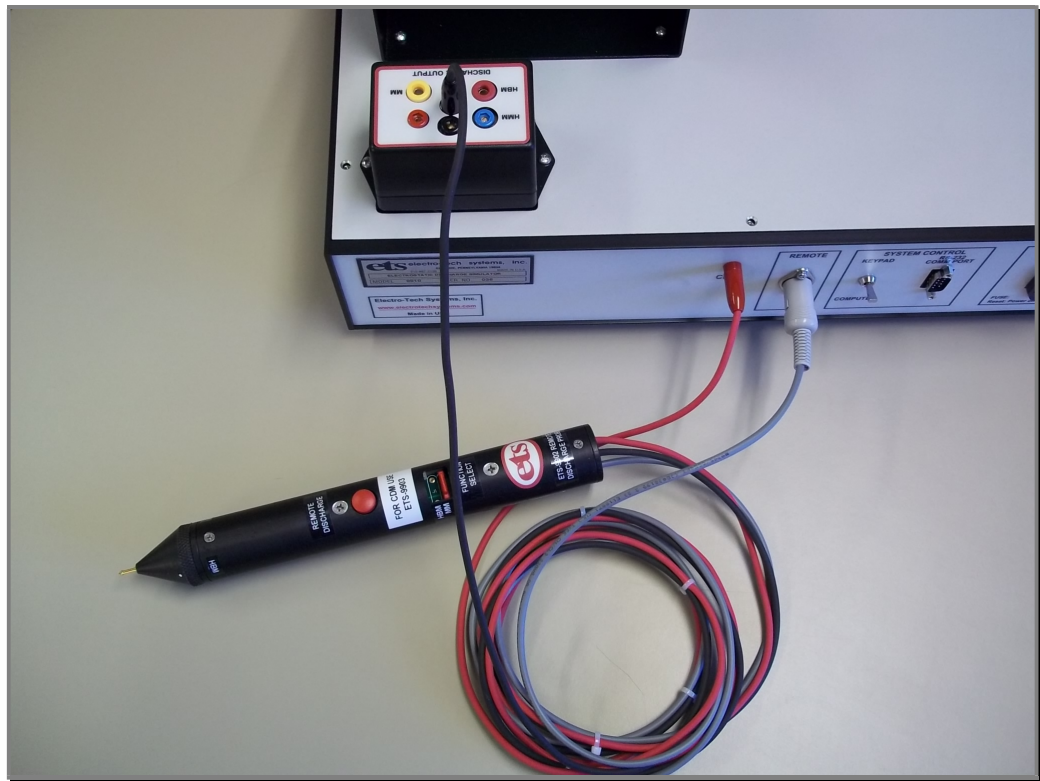

Figure 3.0-1: Probe connection to Model 9910 (modified)

### 3.2 Application

The Model 9902 may be used either by holding the Probe and using the remote discharge button, as shown in Figure 3.0-2, or mounting it to a holding fixture. When mounted to a holding fixture either the discharge head or the remote cable and adapter assemblies can be used. However, for the HBM function each configuration requires a different cable configuration.



Figure 3.0-2: Holding Remote Probe

### 3.3 Function Selection

The discharge waveform from an ESD simulator is very sensitive to stray capacitance and inductance. This is especially true with the HBM network. In a standard simulator such as the Model 9910 these parameters are essentially fixed. However, with a remote discharge set up these parameters can vary thus affecting the discharge waveform, usually the amount of ringing measured. Holding the Probe causes more ringing than using the remote cable set up. Some of this ringing can be addressed by using additional filtering in the ground cable.

The following hook ups for each different function will produce the best waveform for the particular set up.

#### 3.3.1 HBM Testing Holding Probe

Figure 3.0-3 shows the Probe set up for HBM testing with the operator either holding the Probe or with the Probe physically mounted to a fixture. Follow the following procedure:

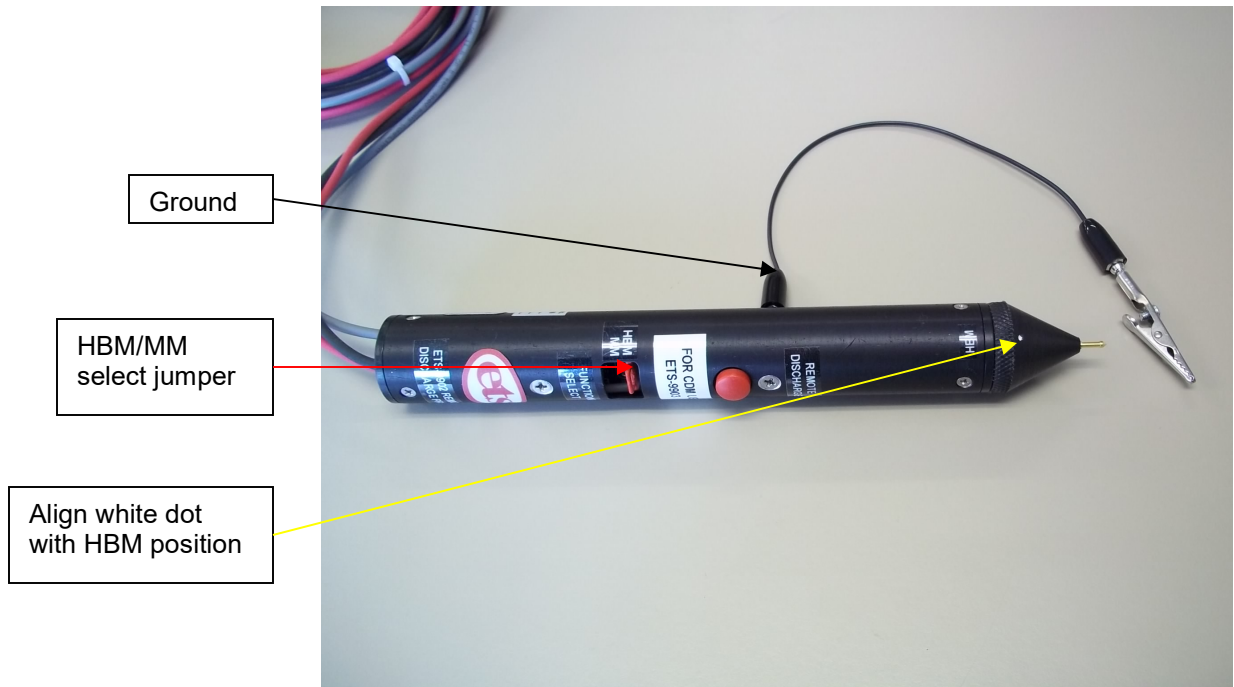

### 3.0-3: Probe set up for HBM handheld or fixed testing

1. Select the HBM function by plugging the Red jumper into the HBM 0.040" pin jacks.
2. Select the HBM output by removing the Discharge Head and plugging into the position where the white dot lines up with HBM.
3. Plug the 9" black lead with Black banana plug into the Black banana jack on the reverse side of the Probe for ground.

### 3.3.2 MM Testing Holding Probe

Refer to Figure 3.0-4 Machine Model set up.

1. Select the MM function by plugging the Red jumper into the MM pin jacks.
2. Select the MM output by removing the Discharge Head and plugging it into the position where the white dot lines up with MM.
3. Plug the 9" black lead with Black banana jack into the black banana jack on the reverse side of the Probe for ground.



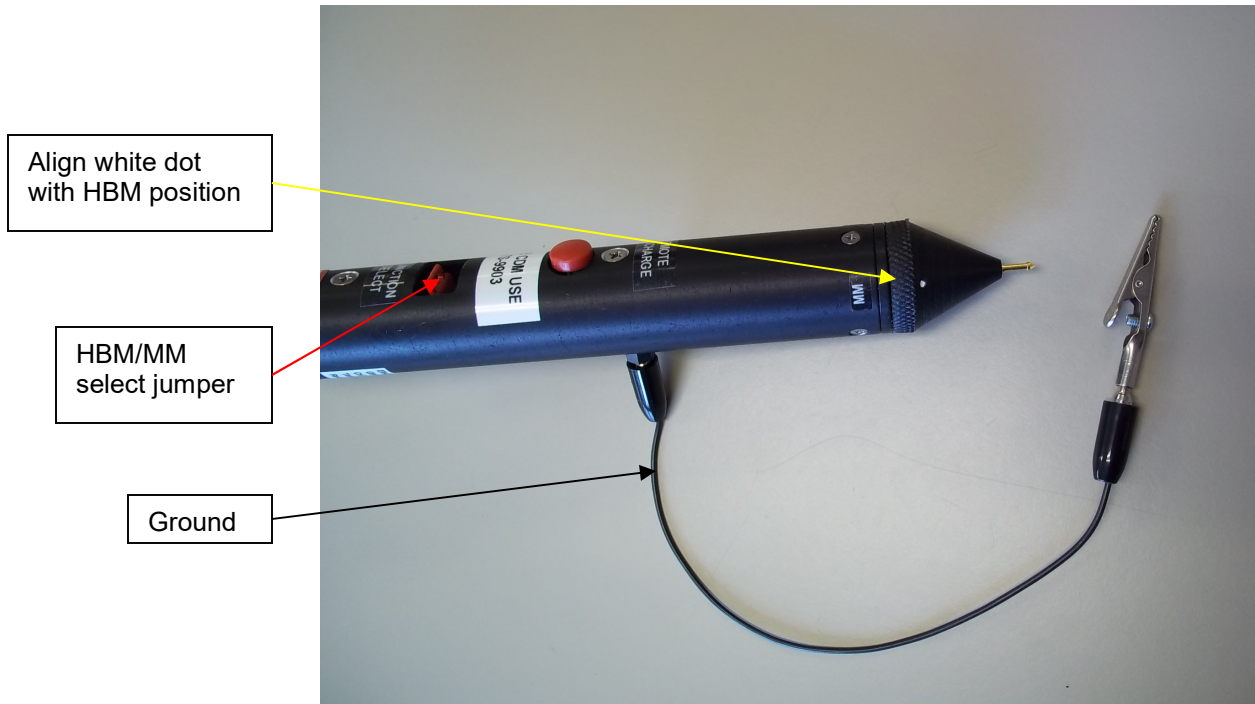

Figure 3.0-4: Probe set up for MM handheld or fixed testing

### 3.3.3 HBM Testing Using External Cables

Remove the Discharge Head. Three banana jacks will be visible. Install the Probe at a convenient location within 9" (305mm) of where the device will be tested. Install the Discharge Pin Adapters at the desired location. Refer to Figure 3.0-5 and proceed as follows:

1. Select the HBM function by plugging the Red jumper into the HBM 0.040" pin jacks.
2. Select the HBM output by plugging the Red 9" lead with Red banana plug into the jack that lines up with HBM designation on the housing.
3. Plug the 9" black lead with the Black banana plug into the Black banana jack on the reverse side of the Probe for ground.
4. Plug both cables into the Discharge and Ground Pin Adapters.



Figure 3.0-5: HBM test set up using external leads

### 1.3.4 MM Testing Using External Cables

Remove the Discharge Head. Three banana jacks will be visible. Install the Probe at a convenient location within 9" (305mm) of where the device will be tested. Install the Discharge Pin Adapters at the desired location. Refer to Figure 3.0-5 and proceed as follows:

1. Select the MM function by plugging the Red jumper into the MM 0.040" pin jacks.
2. Select the MM output by plugging the Yellow 9" lead with Yellow banana plug into the jack that lines up with MM designation on the housing.
3. Plug the 9" black lead with the Black banana plug into the Black banana jack on the reverse side of the Probe for ground.
4. Plug both cables into the Discharge and Ground Pin Adapters.

## 4.0 TEST PROCEDURES

The Charge/Discharge functions of the Model 9902 Remote Probe can be performed using the controls on the front panel of the Simulator or by just depressing the Red Remote Discharge pushbutton on the Probe. The Probe can remain connected if normal Model 9910 testing is to be performed.

## 4.1 Waveform Verification

The various ESD simulator specifications require waveform verification of the discharge pulse. As mentioned previously the waveform measured is a function of probe, lead and current transducer placement.

The following sections show typical waveforms obtained using the various test set ups described above. It is seen that the test set up, especially the lead capacitance and placement affects the HBM waveform ringing and the peak amplitude of the MM. The waveform characteristics can be altered somewhat by adjusting lead placement and/or voltage level to bring the waveform into or close to compliance.

### 4.1.1 HBM @ 1000V to Ground

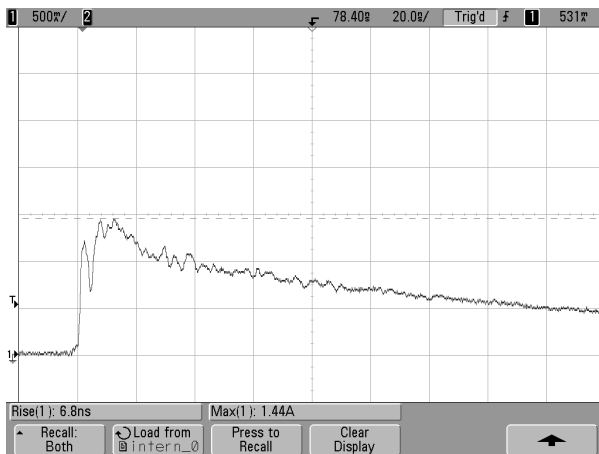

Discharge using 9" leads

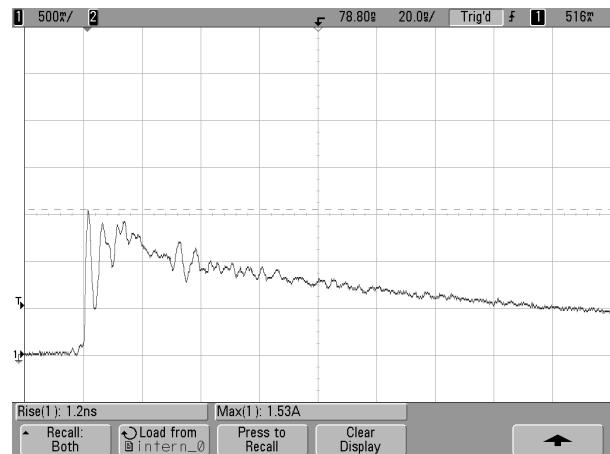

Discharge using Discharge Head

### 4.1.2 MM @ 400V to Ground

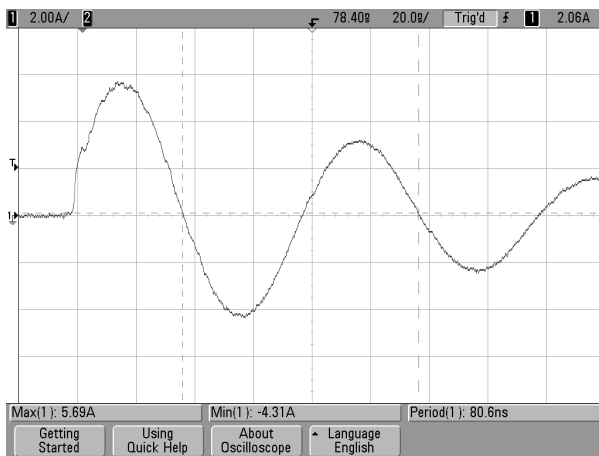

Discharge using 9" leads

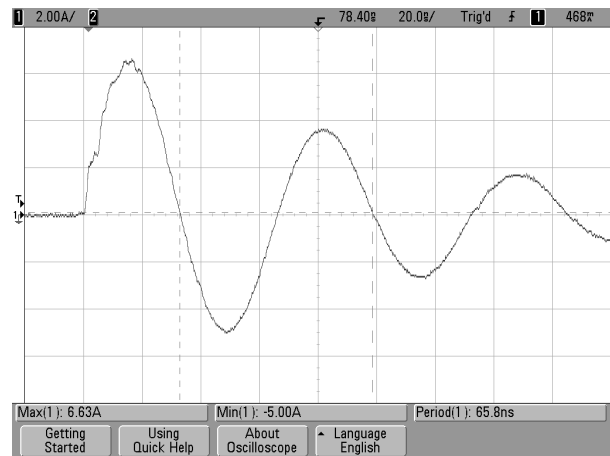

Discharge using Discharge Head

## 5.0 REPAIR AND MAINTENANCE

### 5.1 Repair

The Model 9902 Remote Discharge Probe cannot be serviced by the user. It must be returned to ETS for repair. Contact ETS at 215-887-2196 ext 216 or connect to Calibration Department to obtain an RMA number.

### 5.2 Discharge Contact Pins

The Model 9902 Remote Discharge Probe utilizes gold-plated, spring-loaded, point tip pins as the contact electrode. Each pin requires 5 oz (688 gr) of force for total compression. The electrodes are installed in sockets for easy replacement. ETS currently stocks S4A, S4C, S4F S4H and S4K contact electrodes. Other electrode configurations, shown in Figure 5.0-1, such as smaller diameter, conical, and conductive rubber contact surfaces are available as options.

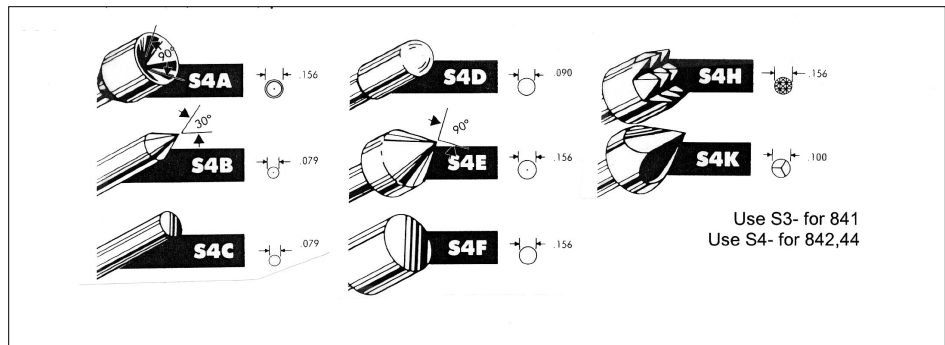

Figure 5.0-1: - Available spring-loaded electrodes

## **6.0 WARRANTY**

Electro-Tech Systems, Inc. warrants its equipment, its accessories and parts of its manufacture to be and remain free from defects in material and workmanship for a period of one (1) year from the date of invoice, and will, at the discretion of Seller, either replace or repair without charge, F.O.B. Glenside, similar equipment or a similar part to replace any equipment or part of its manufacture which, within the above stated time, is proved to have been defective at the time it was sold. All equipment claimed defective must be returned properly identified to the Seller (or presented to one of its agents for inspection). This warranty only applies to equipment operated in accordance with Seller's operating instructions.

Seller's warranty with respect to those parts of the equipment that are purchased from other manufacturers shall be subject only to the manufacturer's warranty. Seller's liability hereunder is expressly limited to repairing or replacing any parts of the equipment manufactured by the manufacturer and found to have been defective. Seller shall not be liable for damage resulting or claimed to result from any cause whatsoever.

This warranty becomes null and void should the Resistance/Resistivity Kit, or any part thereof, be abused or modified by the customer or if used in any application other than that for which it was intended. This warranty to replace or repair is the only warranty, either expressed or implied or provided by law, and is in lieu of all other warranties and the Seller denies any other promise, guarantee, or warranty with respect to the equipment or accessories and, in particular, as to its or their suitability for the purposes of the buyer or its or their performance, either quantitatively or qualitatively or as to the products which it may produce and the buyer is expected to expressly waive rights to any warranty other than that stated herein.

ETS must be notified before any equipment is returned for repair. ETS will issue an RMA (Return Material Authorization) number for return of said equipment. Large equipment should be shipped in the original packaging. If this is not possible, the equipment should be packed in a sufficiently large box of double wall construction with substantial packing around all sides. A description of the problem along with the contact name and telephone number must be included in formal paperwork and enclosed with the instrument. Electro-Tech Systems, Inc. will not assume responsibility for additional cost of repair due to damage Incurred during shipment as a result of poor packaging.

12/17